

## KATALOG STANOVA LOKALI

GRADEVINA: STAMBENO POSLOVNA ZGRADA  
SA PODZEMNIM GARAŽAMA  
UGAO SELSKA – HORVAČANSKA

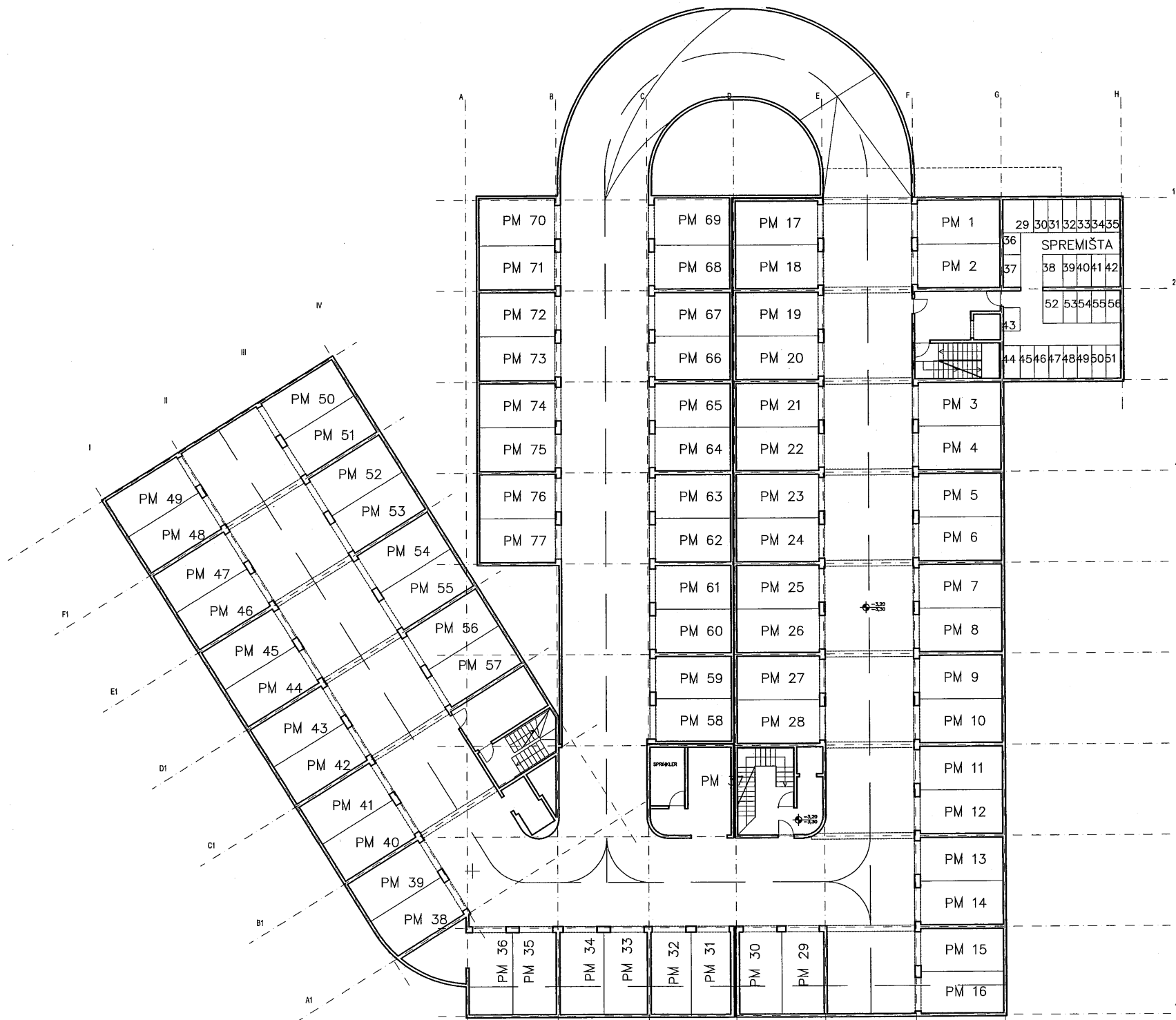

PODRUM - 1

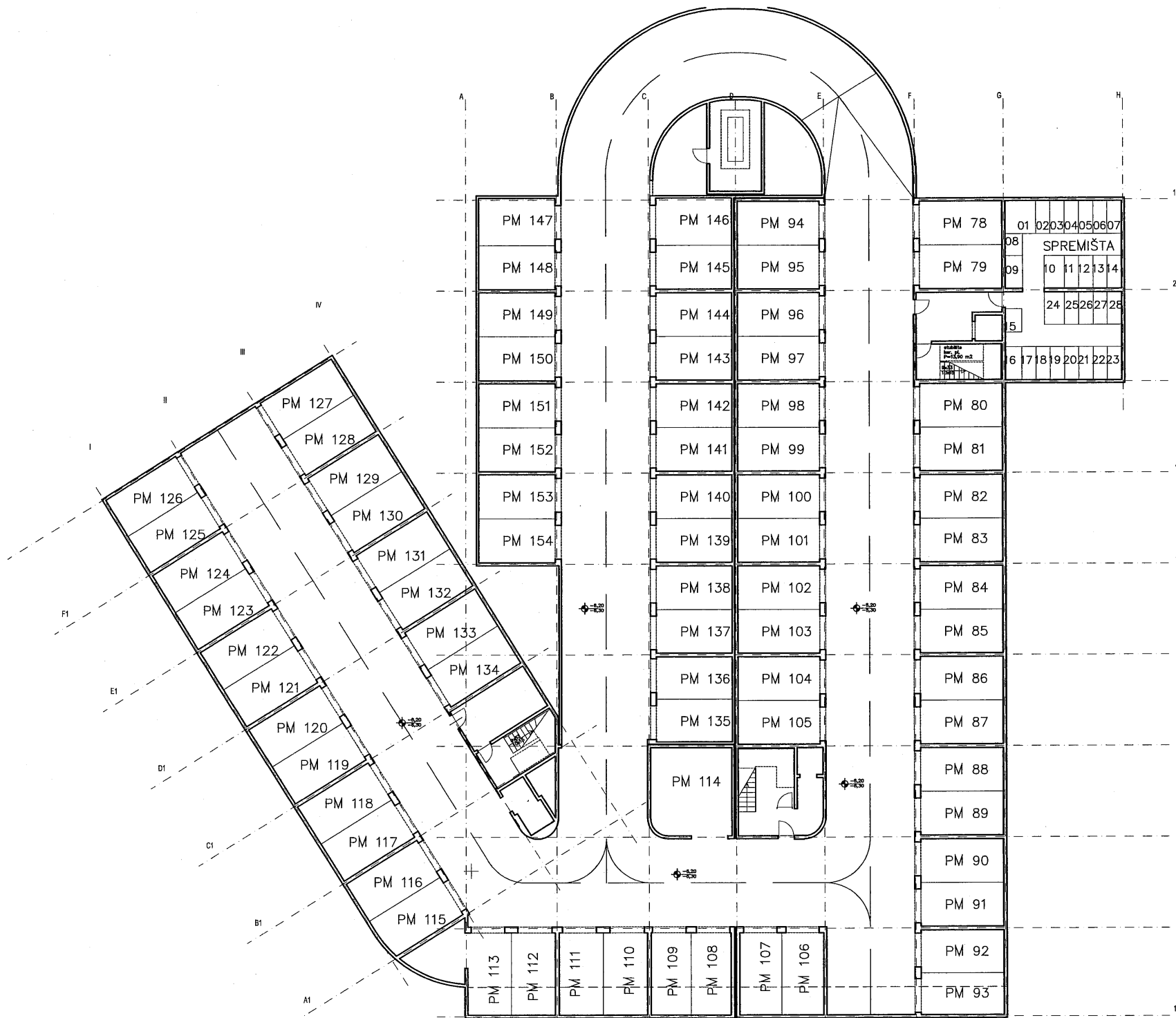

PODRUM - 1

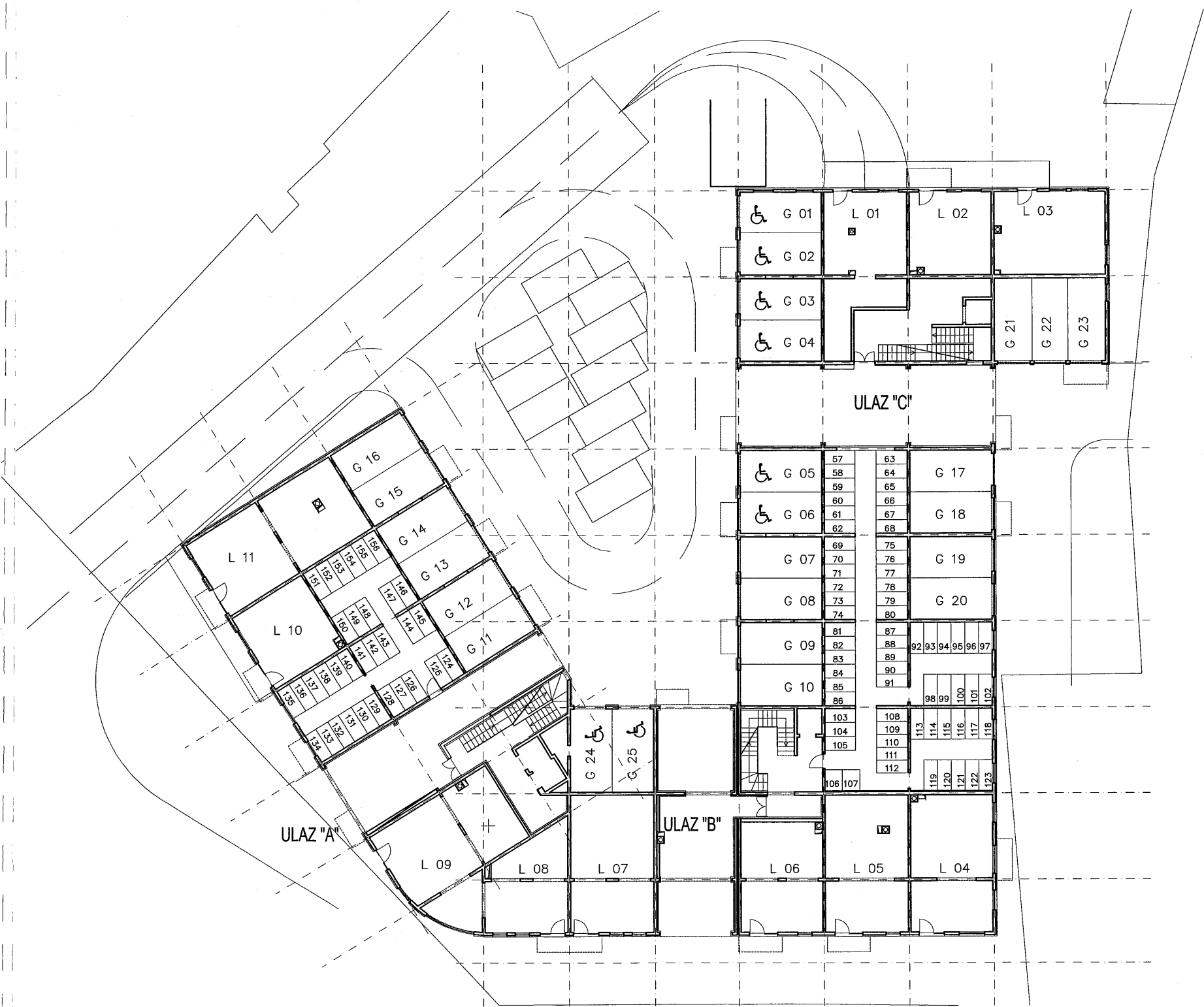

PRIZEMLJE

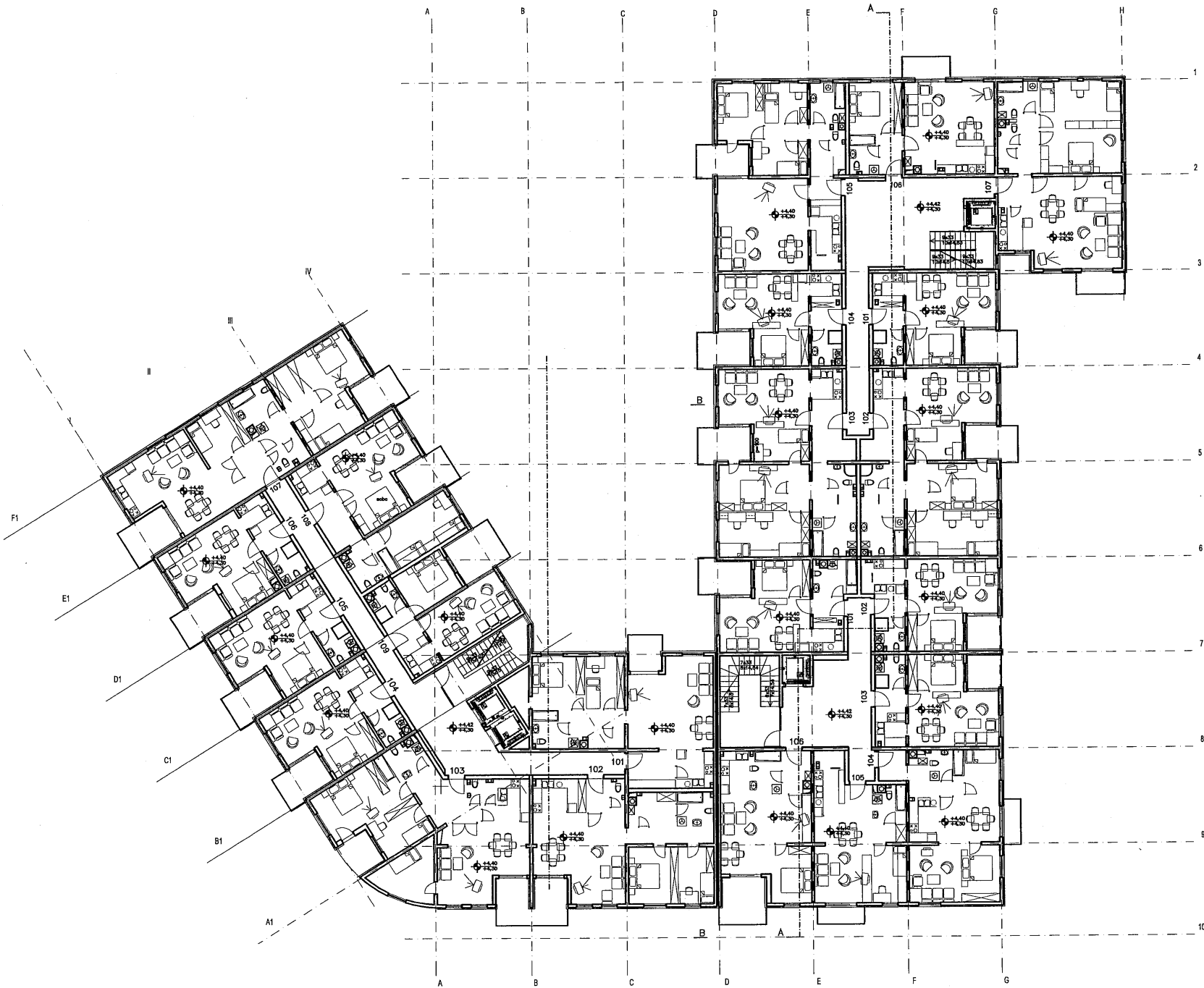

I - VII KATA

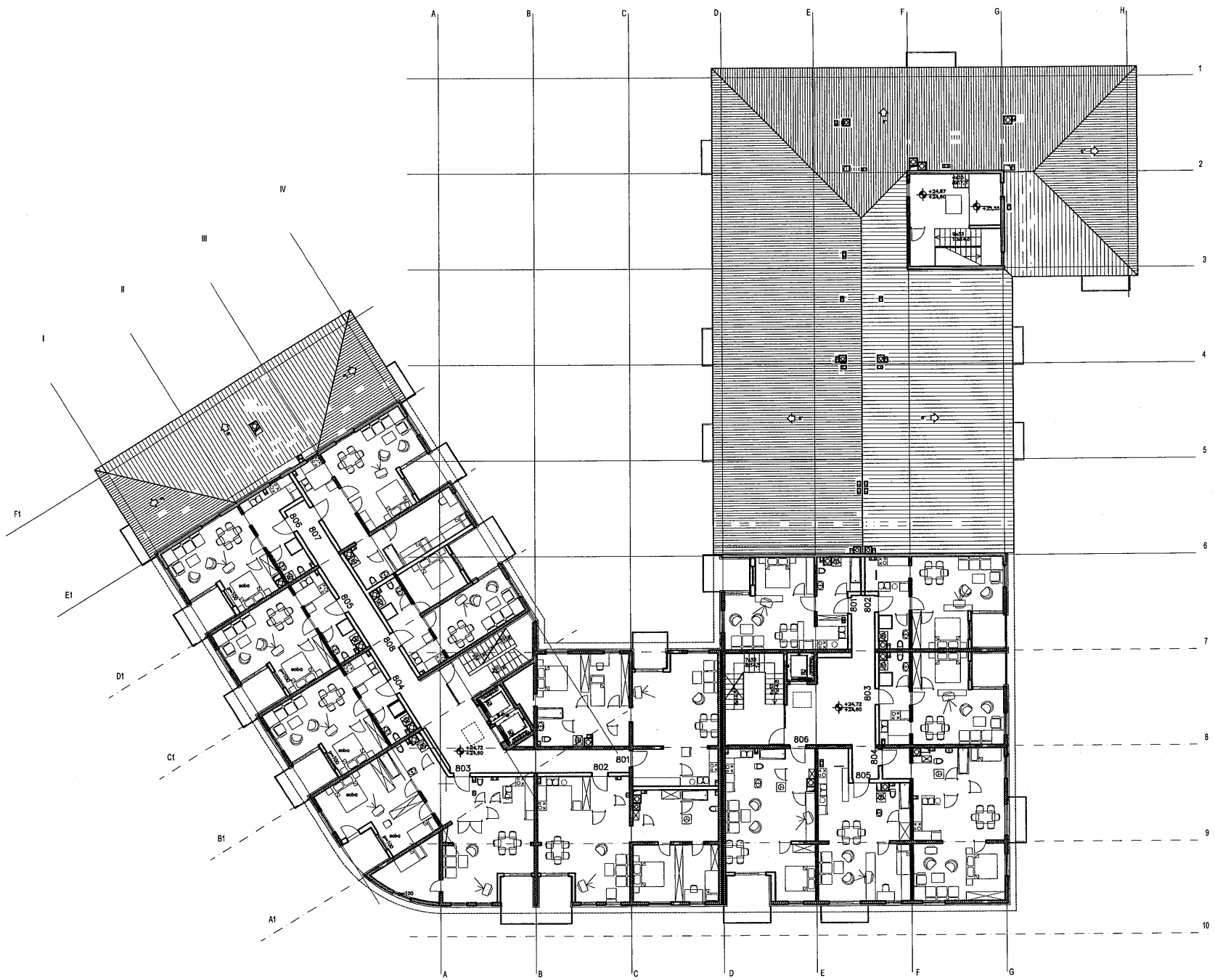

VIII KAT



SJEVERNO PROČELJE



JUGOZAPADNO PROČELJE



JUGOISTOČNO PROČELJE

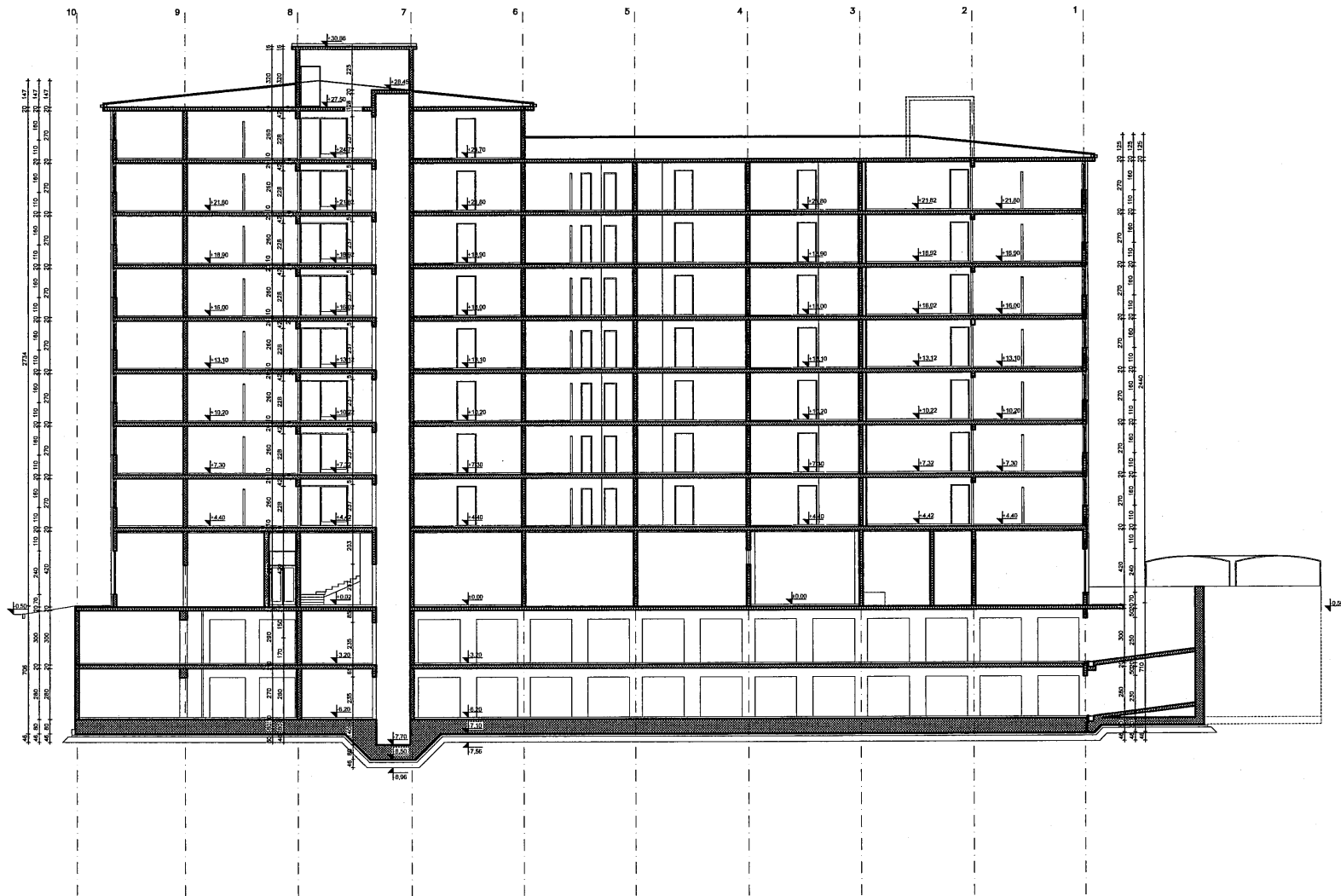

PRESJEK

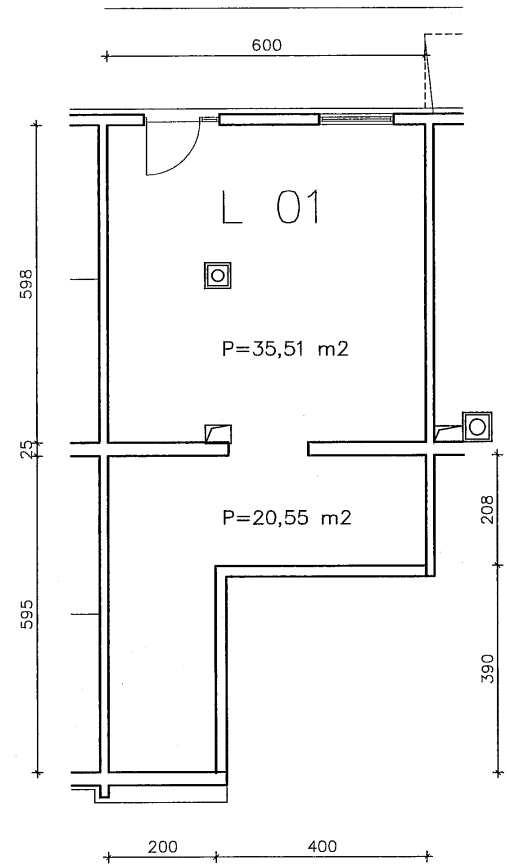
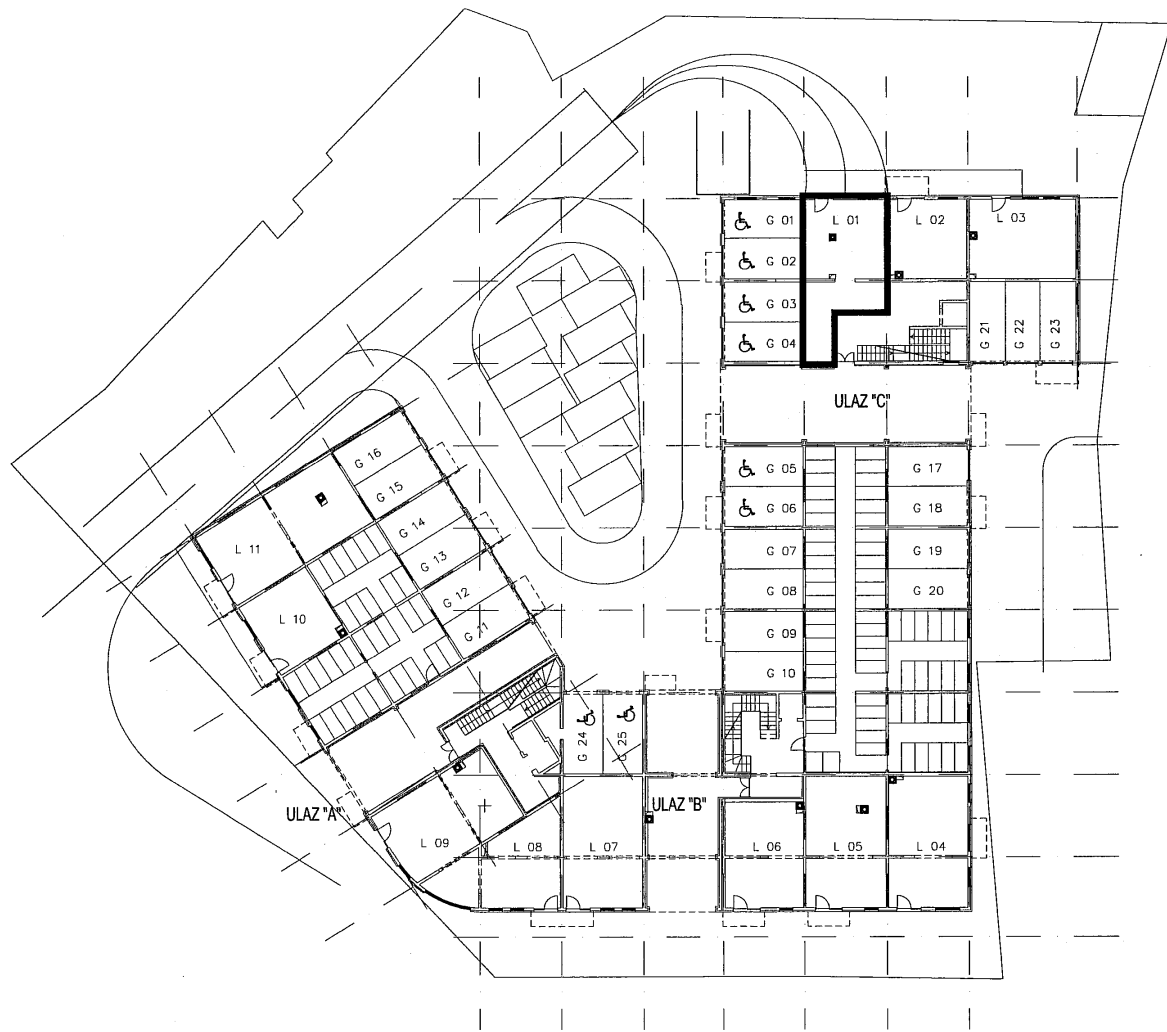

LOKAL L 01 56,06 M2

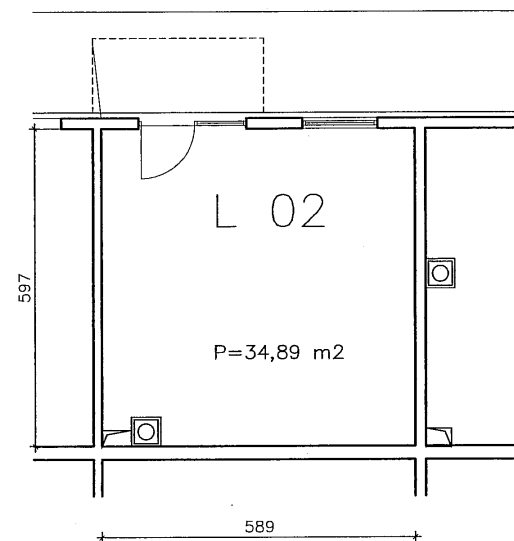

LOKAL	L 02	34,89 M2
-------	------	----------

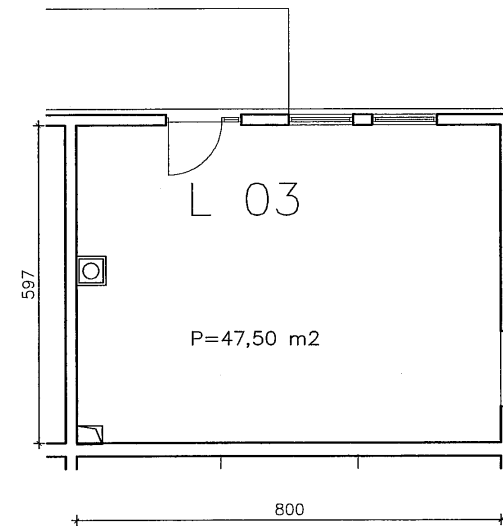

LOKAL	L 03	47,50 M2
-------	------	----------

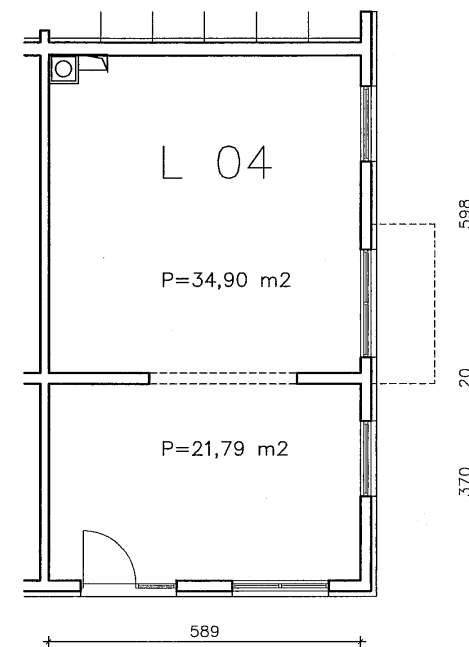
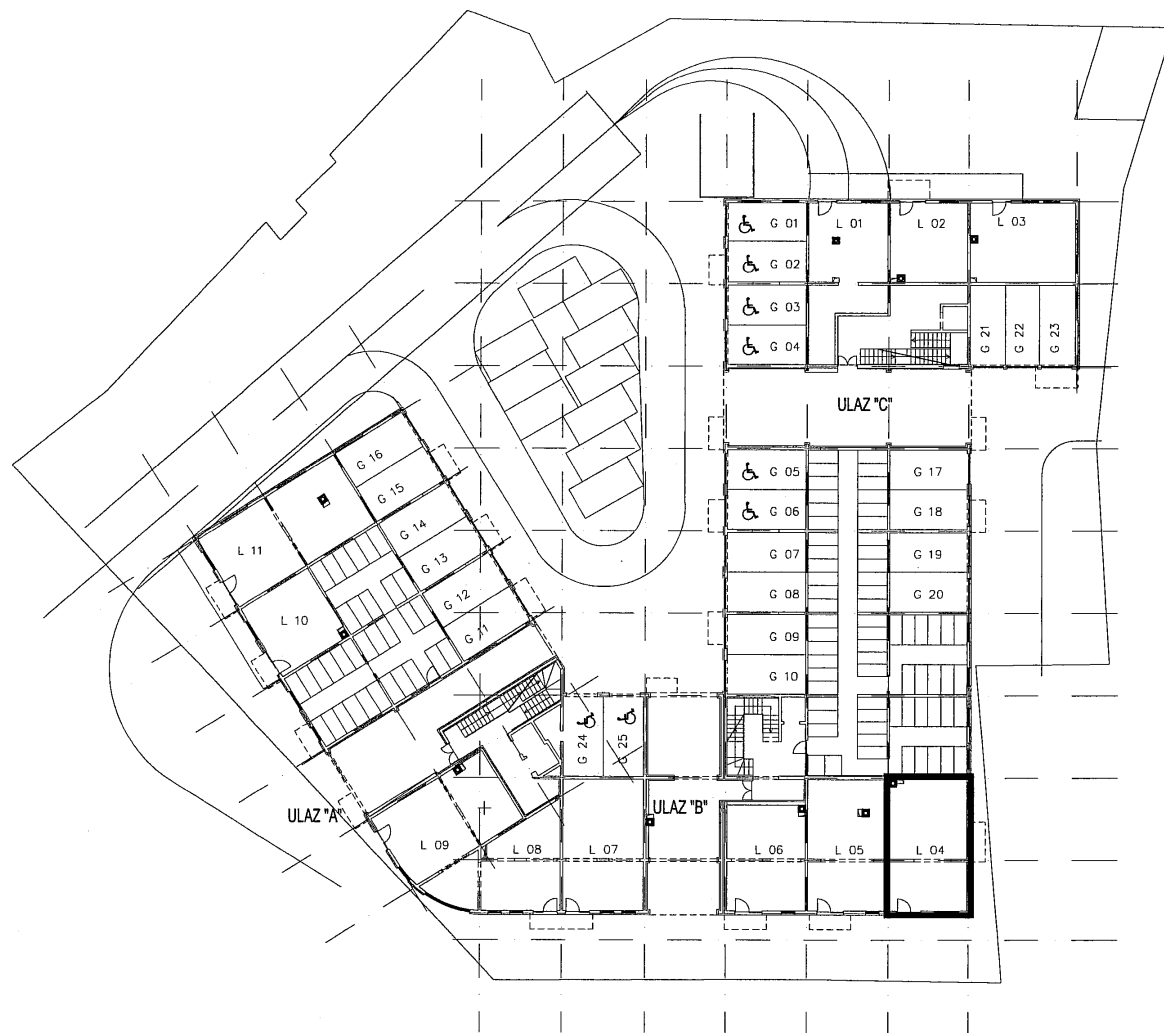

LOKAL	L 04	56,69 M2
-------	------	----------

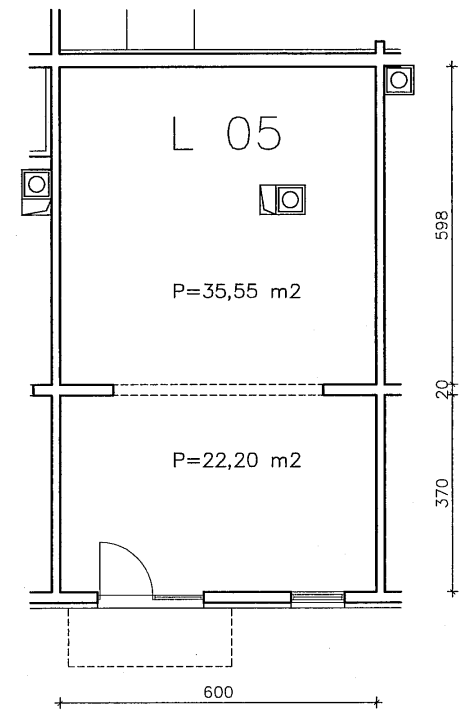
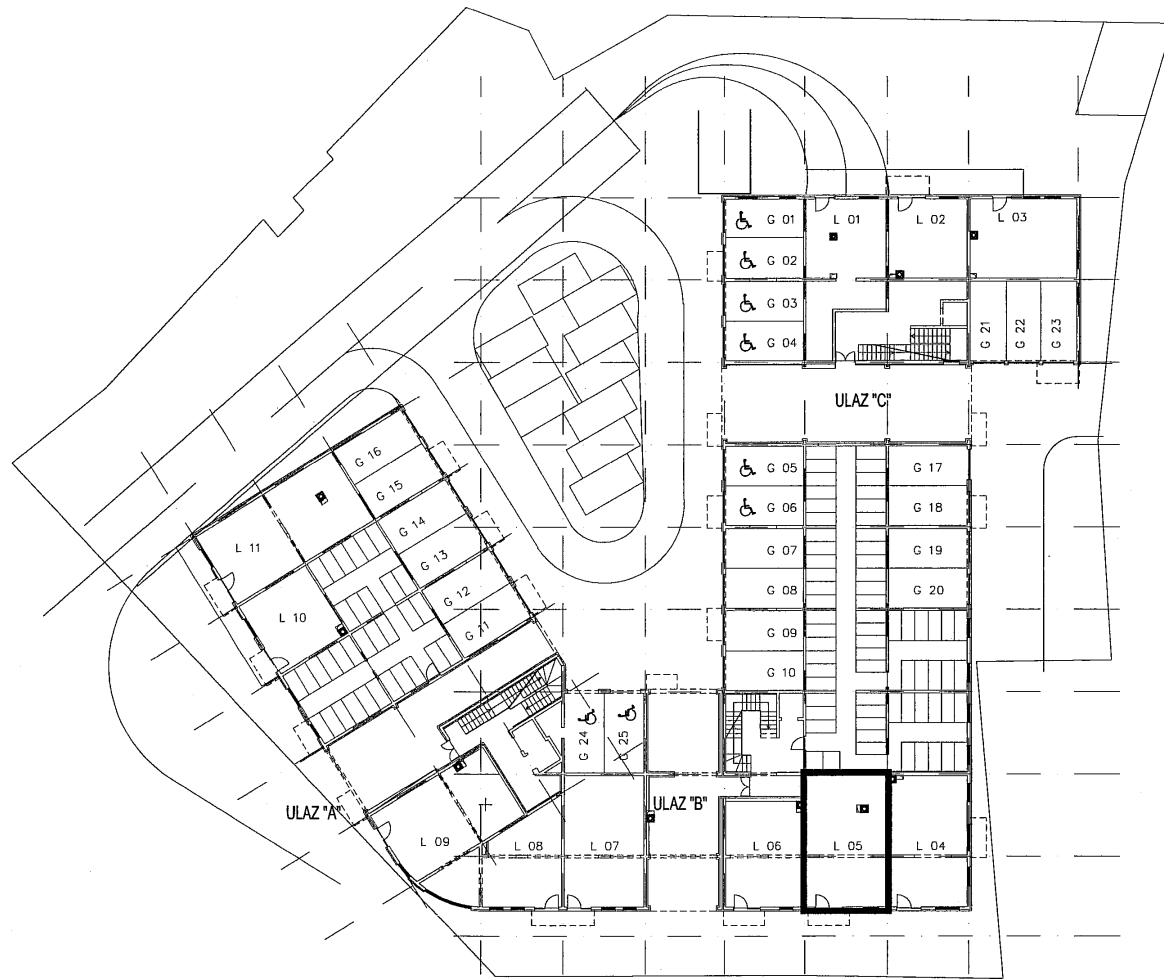

LOKAL L 05 57,75 M2

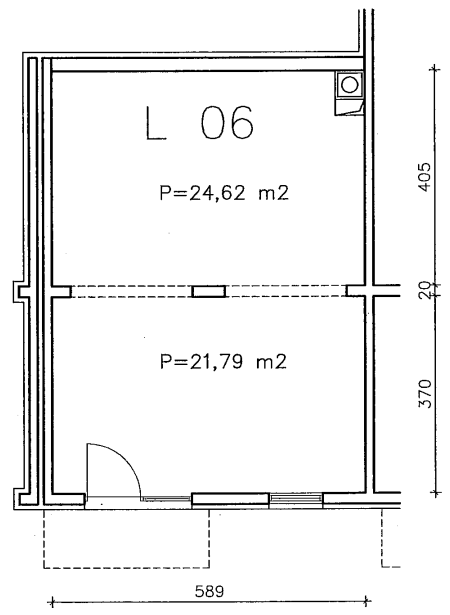

LOKAL	L 06	46,41 M2
-------	------	----------

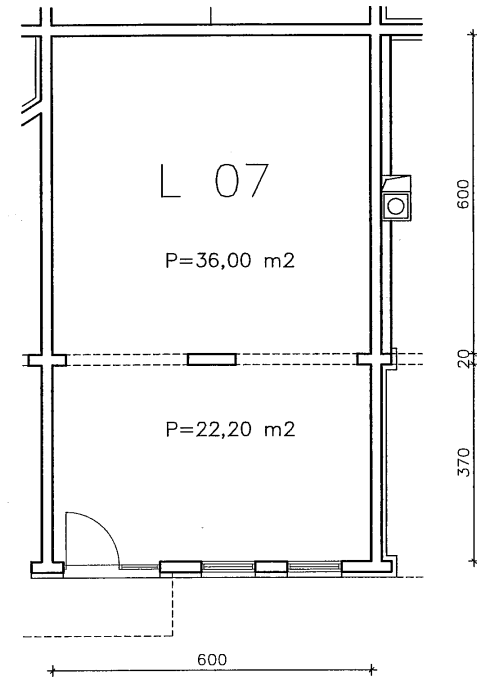
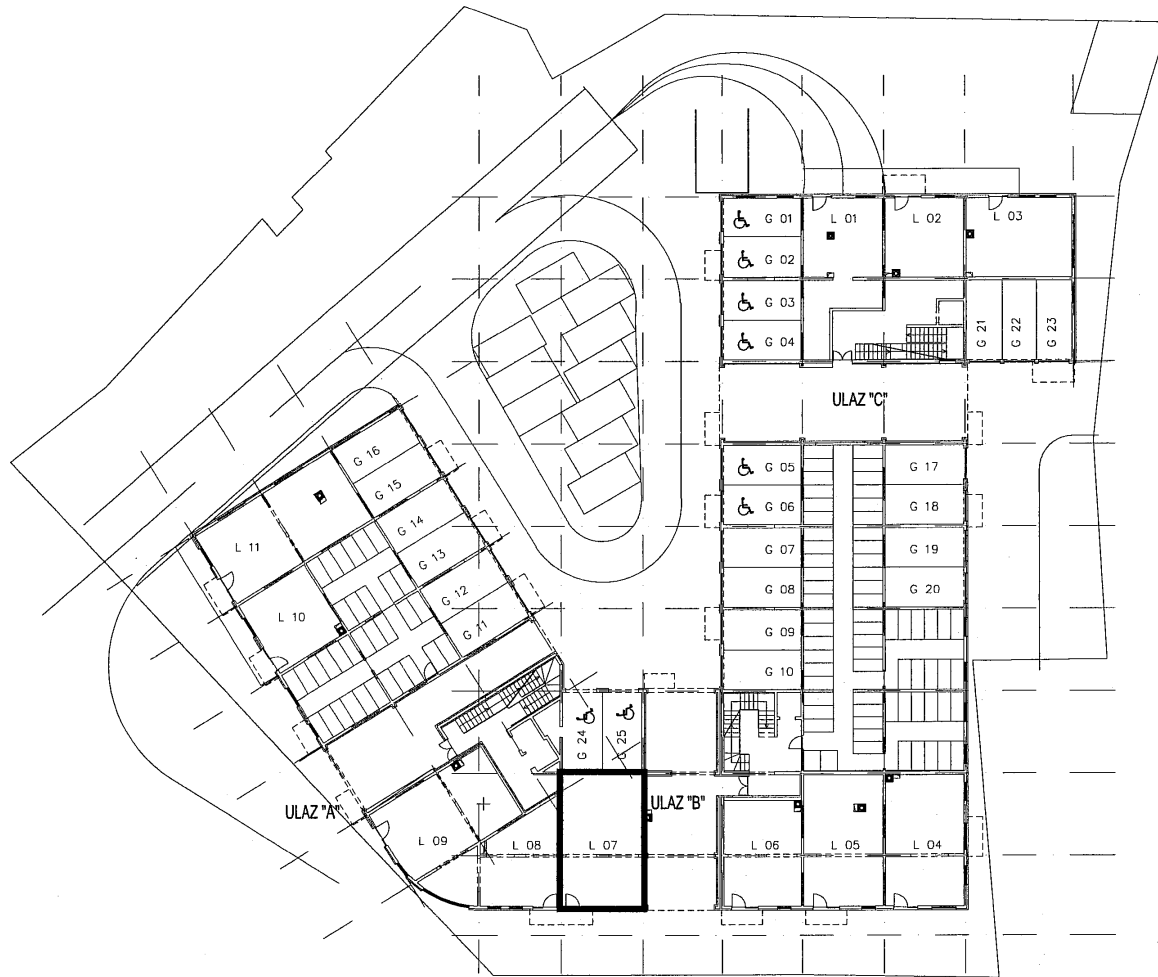

LOKAL L 07 58,20 M2

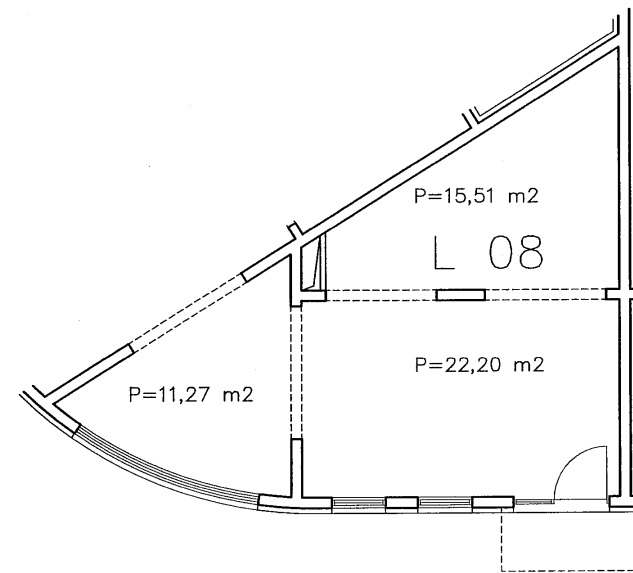
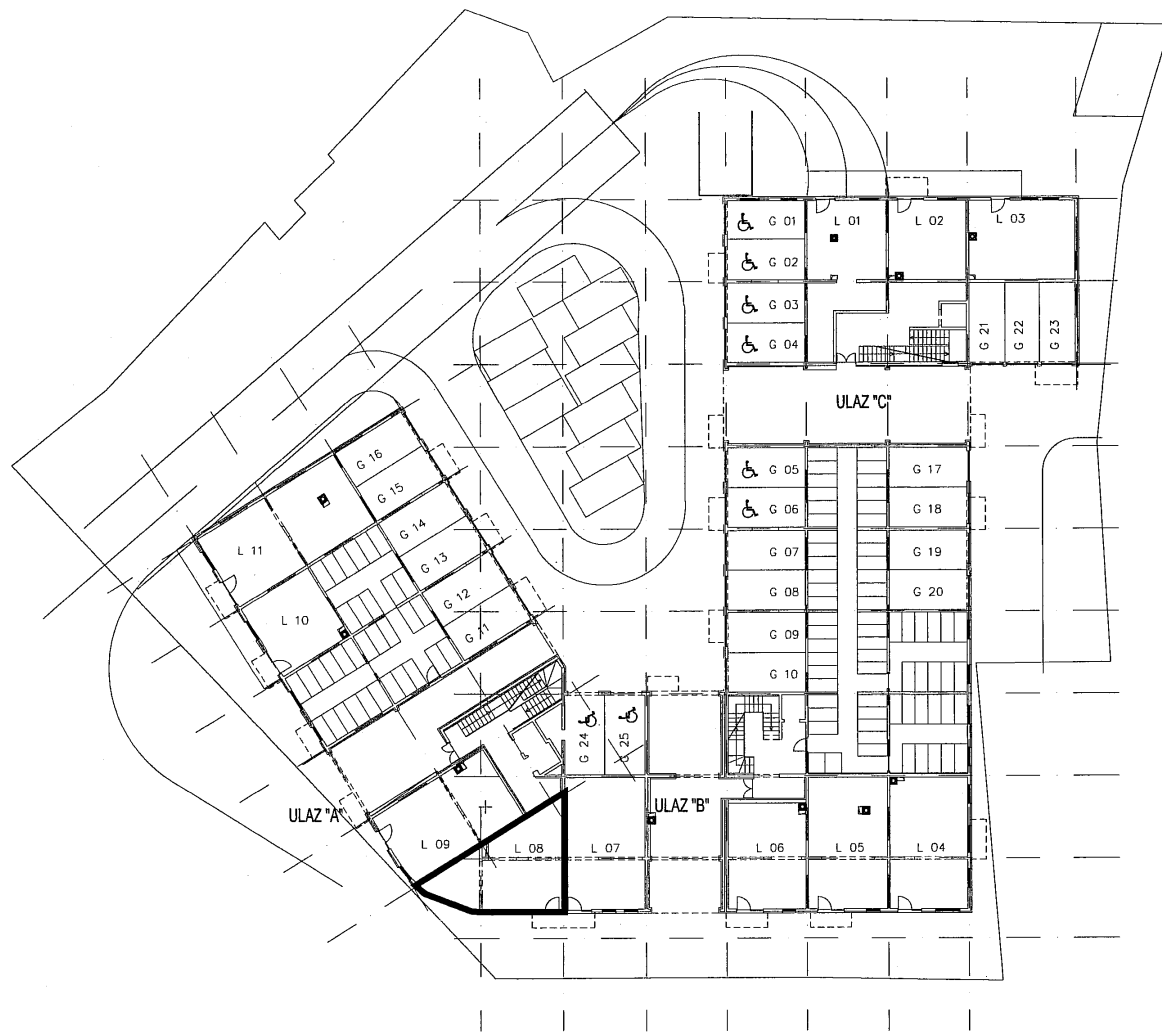

LOKAL	L 08	48,98 M2
-------	------	----------

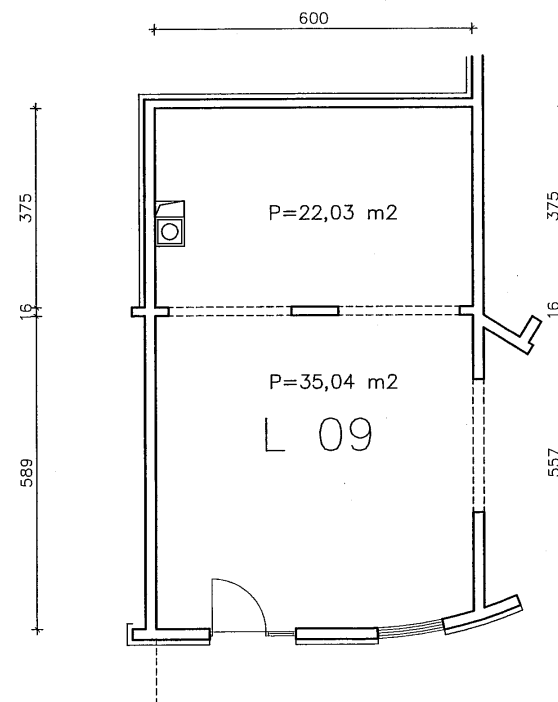
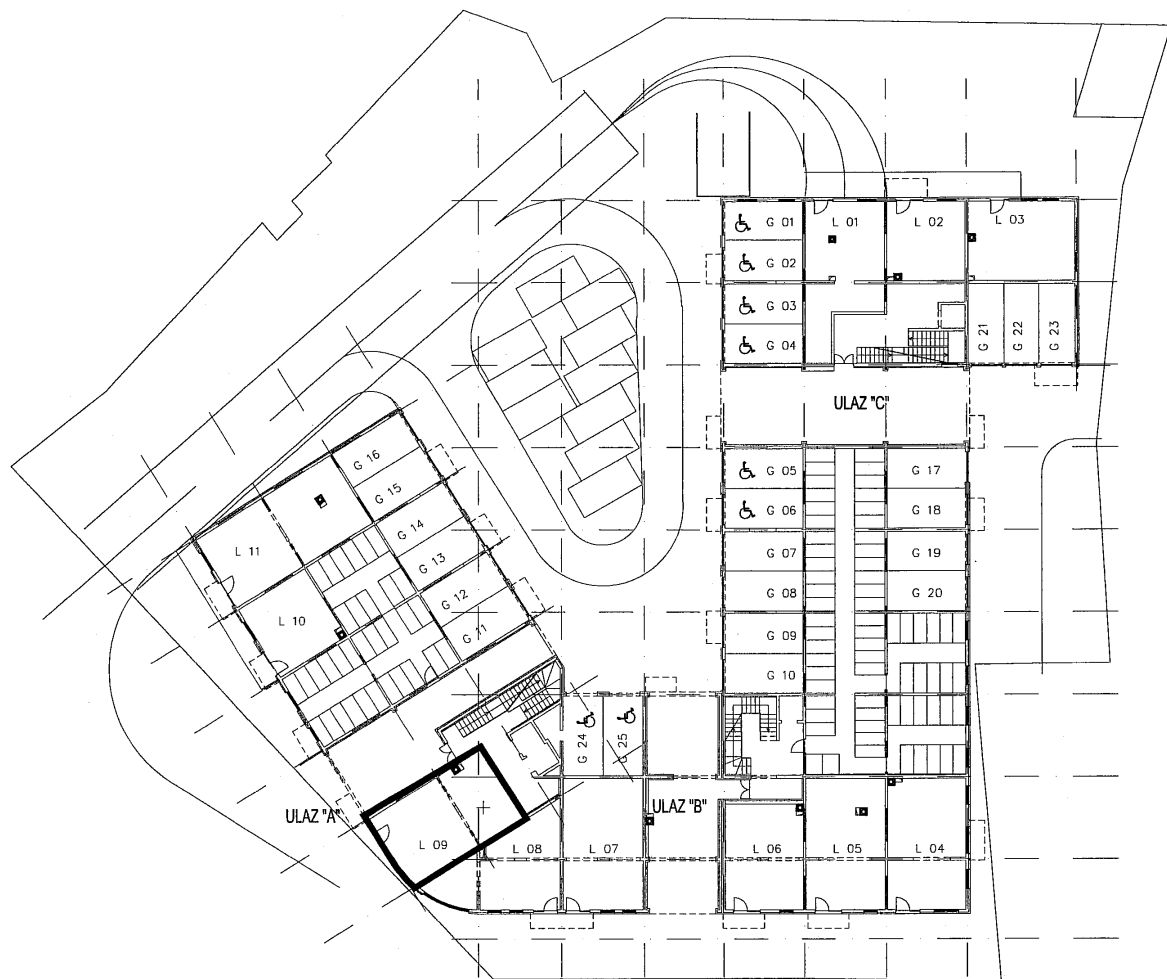

LOKAL	L 09	57,07 M2
-------	------	----------

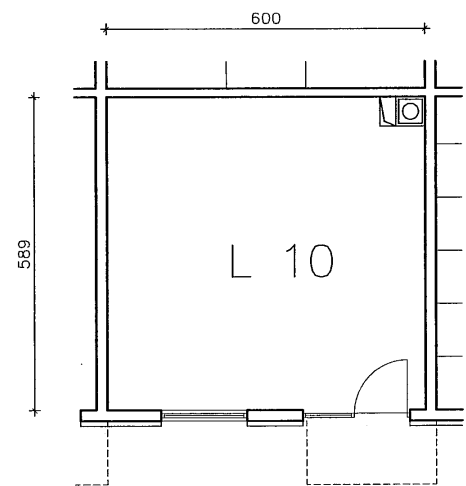
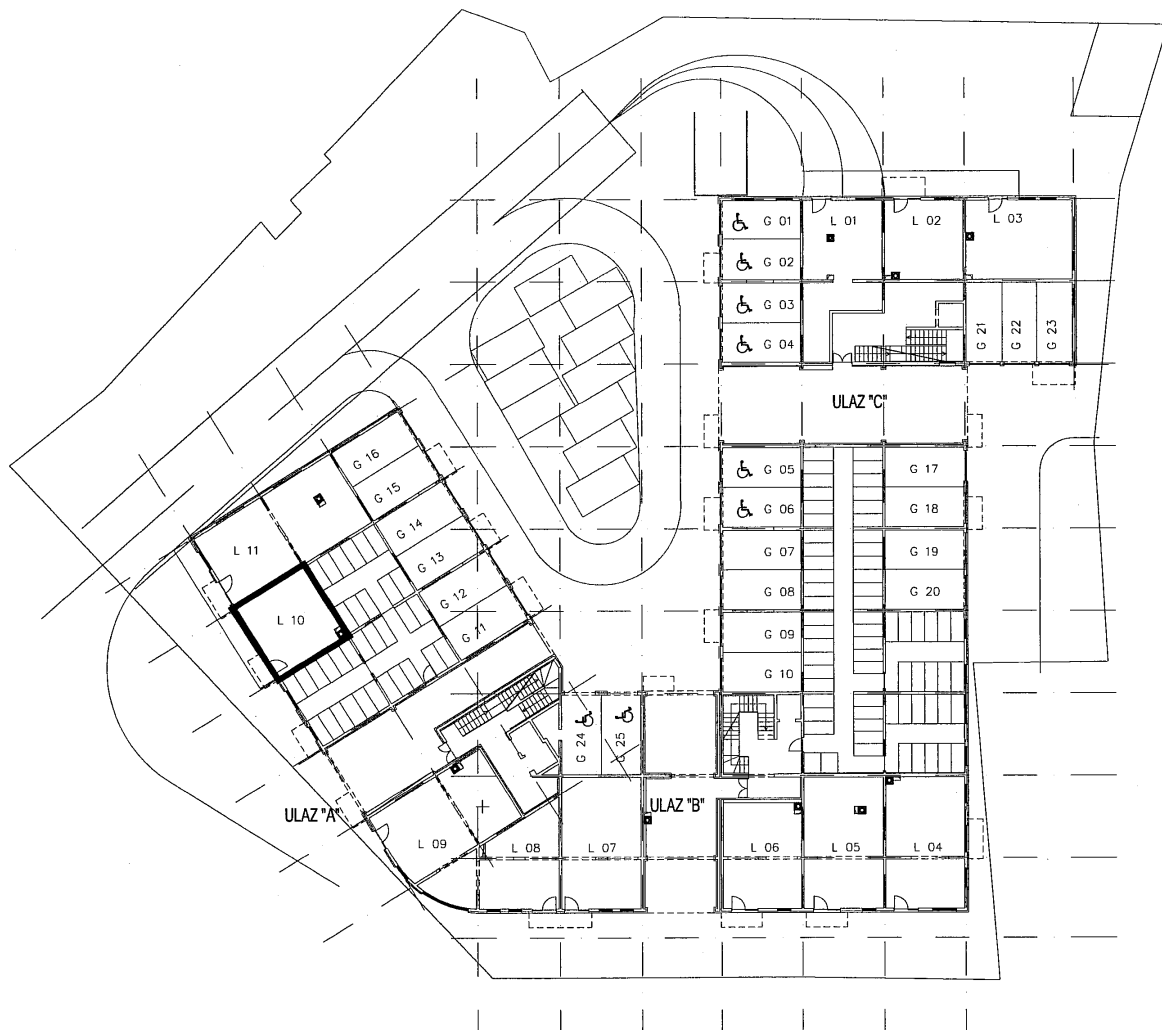

LOKAL	L 10	34,87 M2
-------	------	----------

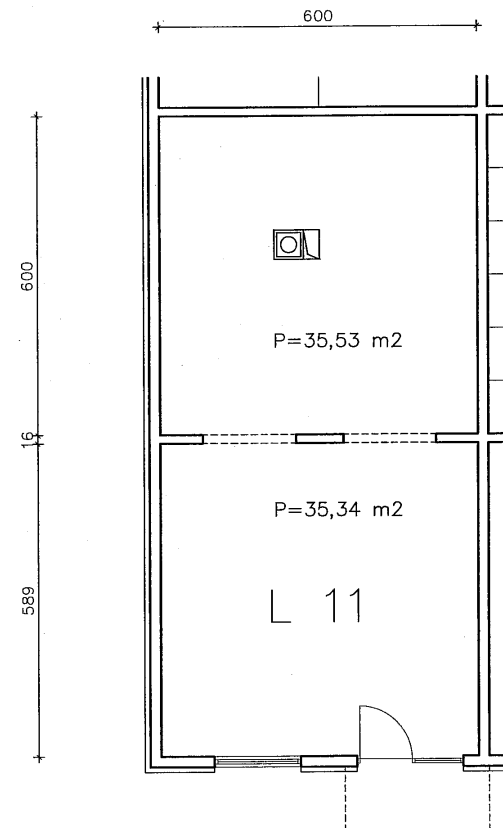

LOKAL L 11 70,87 M2